

MiniBridge®

1.27 mm Connectors

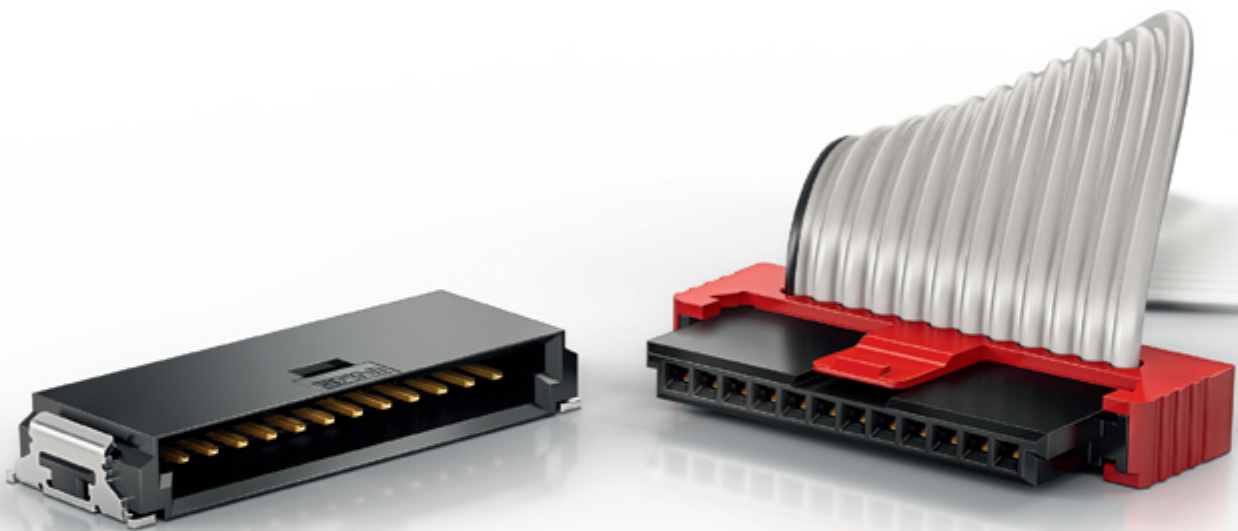

Original Size MiniBridge 12 Pins

ERMEC
www.ermec.com

ERMEC, S.L. BARCELONA
C/ Francisc Teixidó, 22
08918 Badalona
(España)

Tel.: (+34) 902 450 160
Fax: (+34) 902 433 088
info@ermec.com
www.ermec.com

ERMEC, S.L. MADRID
c/Mejorada, 17, 1ª Pla. Of. D4
28850 Torrejón de Ardoz
(España)

ED. 07 | 01.2014

Catalog E 074560

PORTUGAL
portugal@ermec.com
BILBAO
bilbao@ermec.com

MiniBridge - 1.27 mm Connector

SINGLE ROW CONNECTOR —

GENERAL

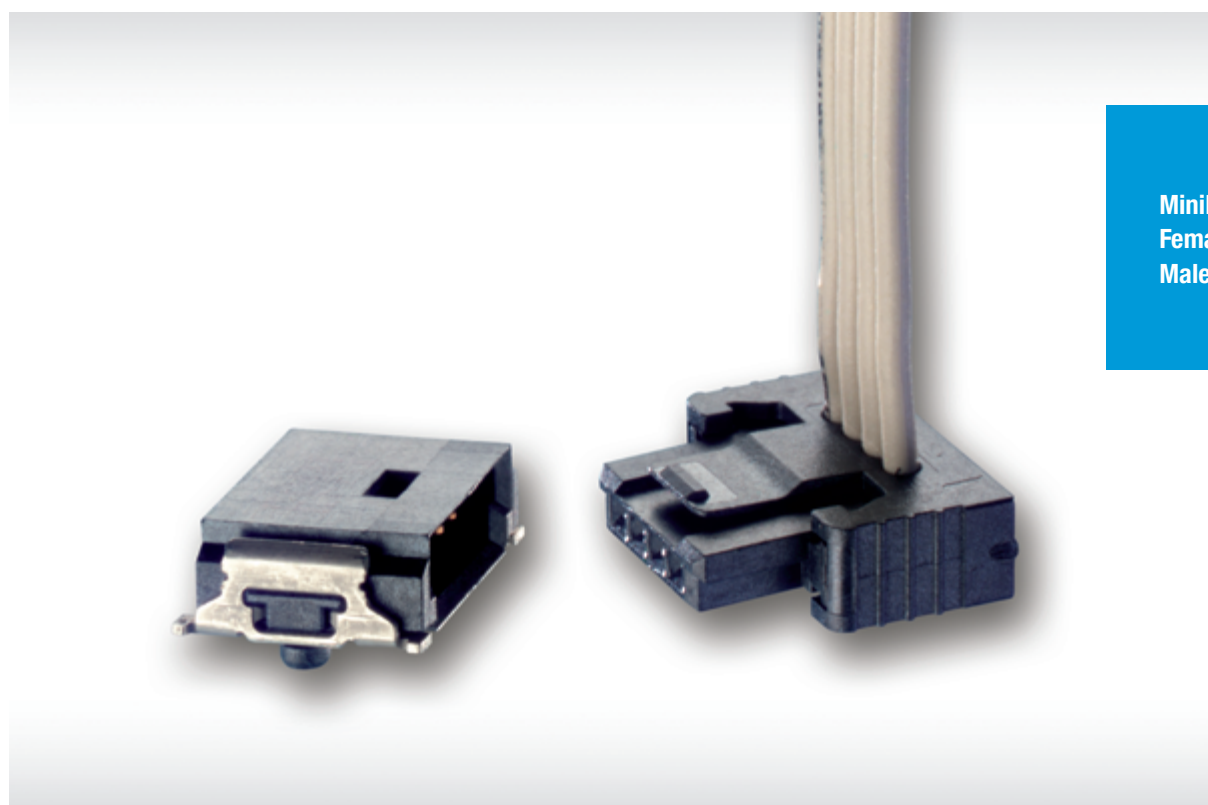

MiniBridge
Female and
Male Connector

The compact design of the single-row cable connector systems in a 1.27 mm pitch is ideal for space-saving connections between PCBs and decentralised function units such as operator panel displays, switches, motors, fans or fuses. The cable connector system is used in various fields for example, automobile industry, mechanical engineering, medical technology and also consumer electronics. Various connection options can be realised thanks to the right angle or vertical male connectors and female connectors with 90° and 180° cable outlets. Both female and male connectors in SMT and IDC* variants are available. The plastic housing is temperature-resistant whereby the connector is suitable for lead-free reflow solde-

ring. The male connectors are available as tape and reel packaging for automatic assembly. The cable guide of the female connector simplifies cable connection or individual wires. Prefabricated cables are available in stock. Specified assemblies are realised within a short time period.

* IDC = Insulation Displacement Connection

MiniBridge - 1.27 mm Connector

SINGLE ROW CONNECTOR

TECHNICAL DETAILS

Pitch	1.27 mm
Current rating per contact	up to 8 A (depends on cable)
Termination	Male connector SMT, female connector IDC
Cable	Ribbon cable AWG 26/7 Discrete wire AWG 22/7, AWG 24/7 and AWG 26/7
Variants	Vertical male connector type P, Right angle male connector type A, Right angle female connector type P, Female connector type A with 180° cable outlet, Female connector type P with 90° cable outlet, Male connector type P with 180° cable outlet
Interlocking	Female connector red (high vibration/shock load) - unlockable only with a tool, e.g. tip of pen Female connector black / white (normal vibration/shock load) - unlockable without any tool

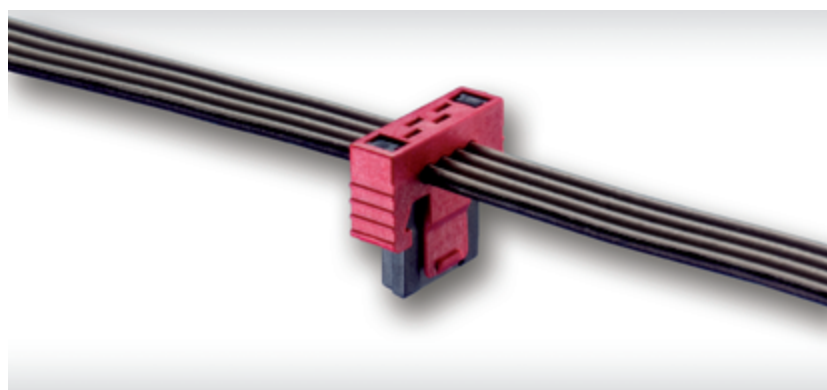

MiniBridge connectors are designed taking into account IEC 60838-2-2 but are not fully compliant.

MiniBridge - 1.27 mm Connector

FEATURES —

AVAILABLE TERMINATIONS

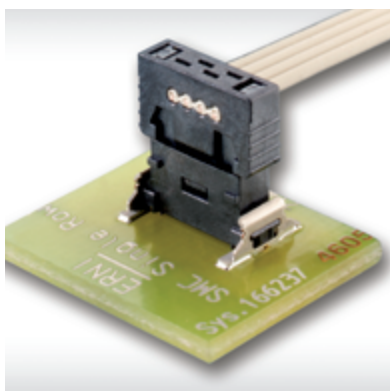

Vertical male -
Female with 90° cable outlet

Right angle male -
Female with 90° cable outlet

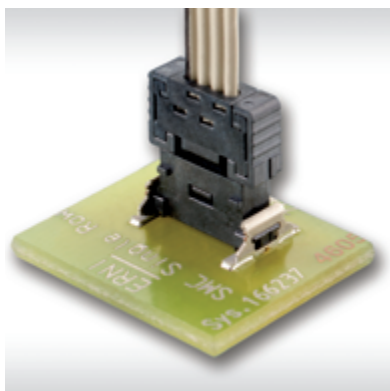
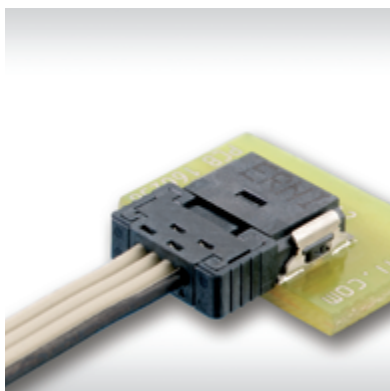
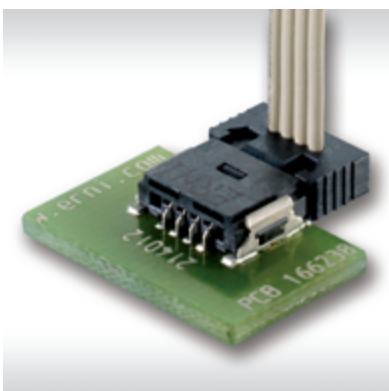

Right angle male -
Female with 180° cable outlet

Vertical male -
Female with 180° cable outlet

Female and male with 180°
cable outlet

Right angle male -
Right angle female

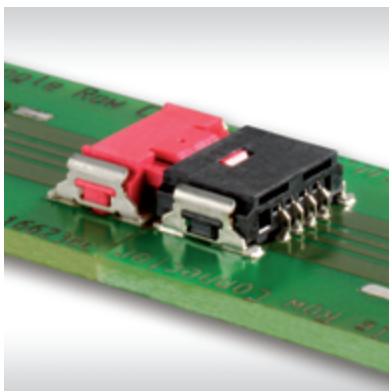
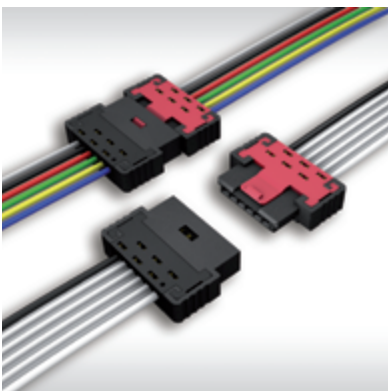

MiniBridge - 1.27 mm Connector

FEATURES

CABLE TYPES

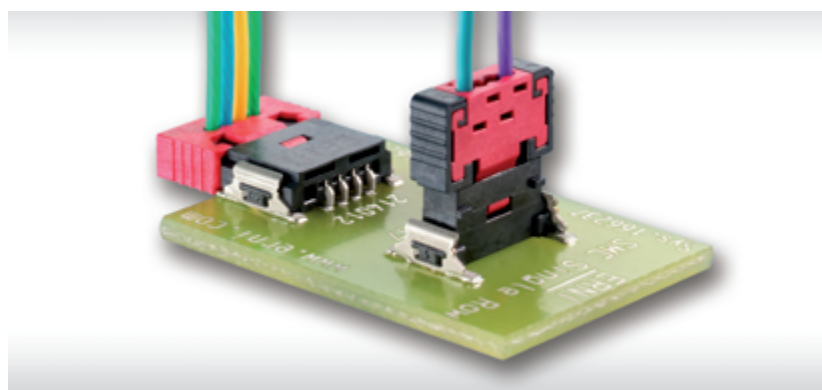

Ribbon cable, grid patterned cable, discrete wire and round cable

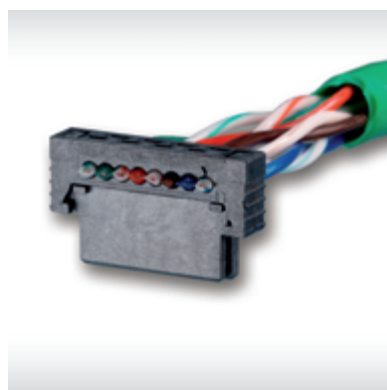

MiniBridge - 1.27 mm Connector

FEATURES

EASY ASSEMBLY

Pick-and-place cover for automatic assembly with a vacuum pipette.

Reliable retention force due to ruggedized **metal clips** on both sides of each male.

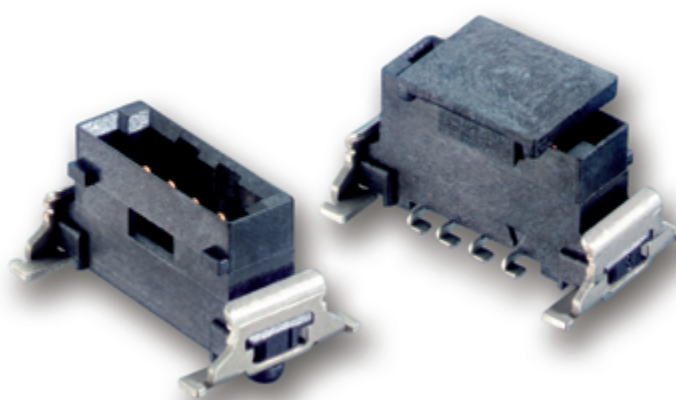

GUIDING ELEMENTS

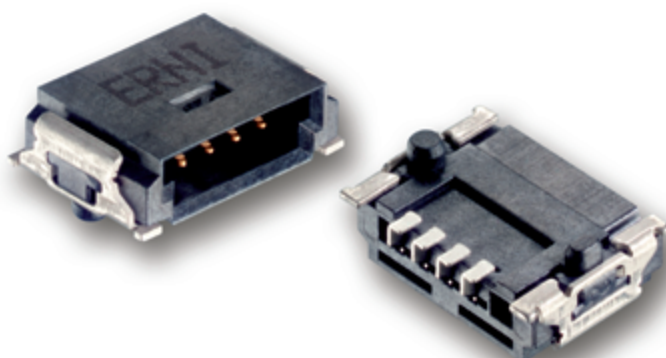

The rugged **insulation body** of the male connector ensures an optimal cable connector guide.

Two **pegs** (round and oval) for exact positioning on the pcb.

MiniBridge - 1.27 mm Connector

FEATURES —

INTERLOCKING

Positive lock (red): un (high vibration/Shock load) lockable only with a tool, e.g. tip of pen

Friction lock (black): (normal vibration/shock load) unlockable without any tool

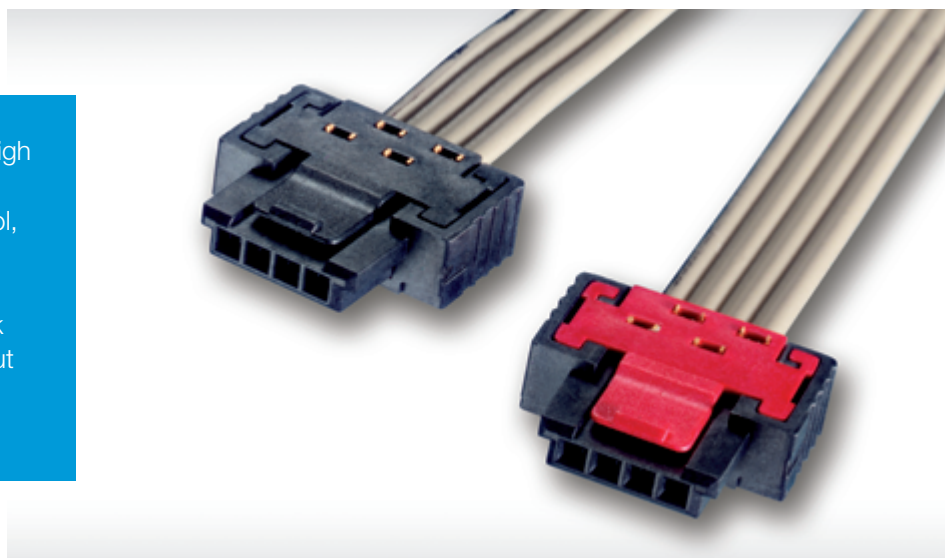

SSL-LIGHTING TECHNOLOGY

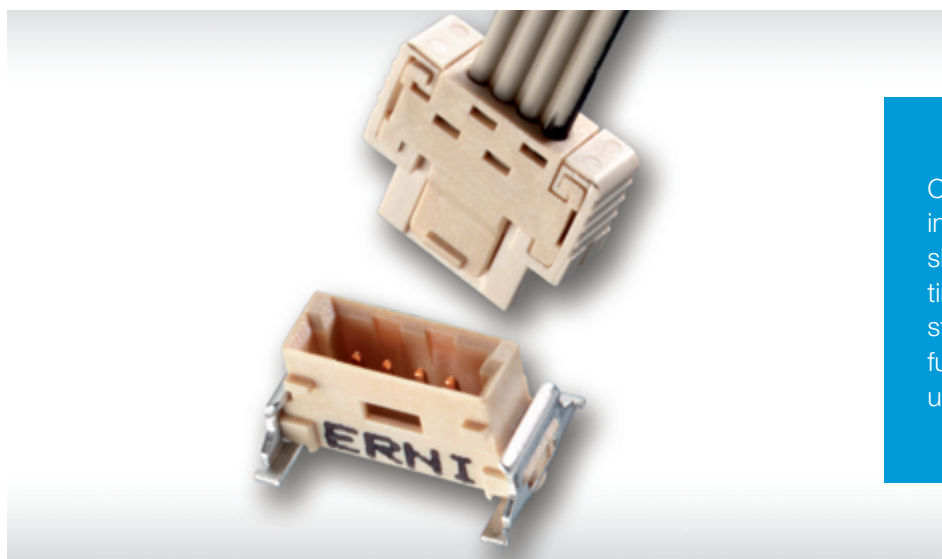

Connectors with colourless insulation bodies prevent shadow formation in lighting applications, e.g. LED strips with transparent diffusion disks. Thus ensuring uniform light distribution.

MiniBridge - 1.27 mm Connector

MATING CONDITIONS —

ALLOWED ANGULAR INCLINATION TOLERANCES, LONGITUDINAL 4.3°

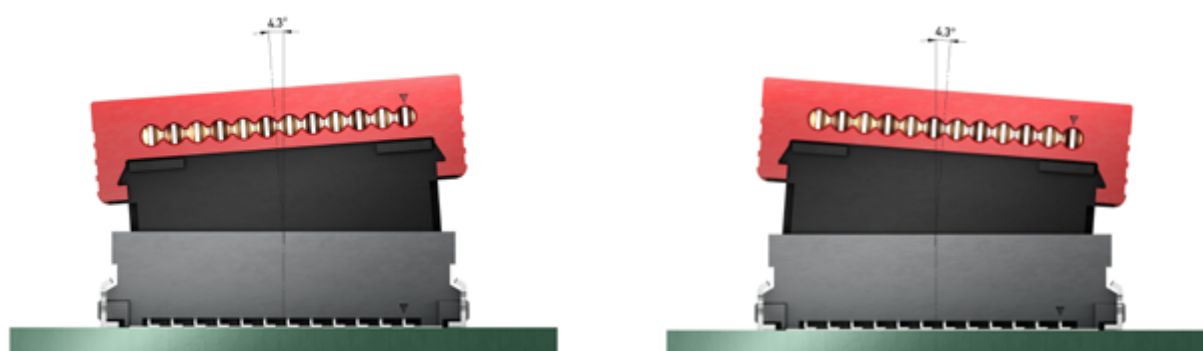

ALLOWED ANGULAR INCLINATION TOLERANCES, TRANSVERSE 3.1°



MiniBridge - 1.27 mm Connector

ELECTRICAL AND MECHANICAL CHARACTERISTICS SMT

TECHNICAL DATA

Description	Standard	Male Connector SMT Type A and P	Female Connector SMT Type P
Climate category	DIN EN 60068-1 test b	55 / 150 / 56	55 / 125 / 56
Temperature range		-55 / 150 °C	-55 / 125 °C
Current rating per contact	IEC60512 test 5b	see IDC or SMT female connector	20 C° max. 4.8 A 70 C° max. 3.2 A 100 C° max. 2.0 A
Air- and creepage distance		contact - contact 0.4 mm	
Operating voltage	IEC 60664	<p>The permissible operating voltages depend on the customer application and on the applicable or specified safety requirements. Insulation coordination according to IEC 60664-1 has to be regarded for the complete electrical device. Therefore, the maximum creepage and clearance distances of the mated connectors are specified for consideration as a part of the whole current path. In practice, reductions in creepage or clearance distances may occur due to the conductive pattern of the printed board or the wiring used, and have to be taken into account separately. As a result the creepage and clearance distances for the application may be reduced compared to those of the connector.</p>	
Dielectric strength	IEC 60512 test 4a	contact – contact 500 V _{rms}	
Contact resistance	IEC 60512 test 2a	< 25 mΩ	
Insulation resistance	IEC 60512 test 3a	> 10 ⁴ MΩ	
Vibration, sine	IEC 60512 test 6d	10 – 2000 Hz 20 g	
Contact disturbance (while vibration test)	IEC 60512 test 2e	< 1 μs	
Shock halfsine	IEC 60512 test 6c	50 g 11 ms	
Contact disturbance (while shock test)	IEC 60512 test 2e	< 1 μs	

MiniBridge - 1.27 mm Connector

ELECTRICAL AND MECHANICAL CHARACTERISTICS SMT

Description	Standard	Male Connector SMT Type A and P	Female Connector SMT Type P
Mechanical operation	IEC 60512 test 9a		500 mating cycles
Insertion and withdrawal force	IEC 60512 test 13b		1 N per contact
Gauge retention force	IEC 60512 test 16e		> 0.1 N
Polarization	IEC 60512-13-5		60 N
Interlocking noise			40 dB (A)
Process-conditions			
Solder temperature max.	IEC 60068-2-20		
Hand soldering temperature max.			3.5 s at 350 °C
Reflow soldering temperature max.	JEDEC J-STD-020		20 - 40 s at 260 °C
Coplanarity			< 0.1 mm
Housing Material			
Plastic material			LCP
CTI value	IEC 112		175
UL flame rating			UL 94 V-0
UL file			E83005
Contact Material			
Base material			Cu alloy
Mating area			gold plating
Termination area			Sn
Environment compatibility			
Recycling			no flame-retardent additives, no toxic additives allow easy recycling
Product-approval			
UL			E84703

MiniBridge - 1.27 mm Connector

ELECTRICAL AND MECHANICAL CHARACTERISTICS IDC

TECHNICAL DATA

Description	Standard	Male Connector IDC Type P	Female Connector IDC Type A and P
Climate category	DIN EN 60068-1 test b	55 / 150 / 56	
Temperature range			-55 / 150 °C
Current rating per contact	IEC60512 test 5b	see IDC or SMT female connector	20 C° max. 8.7 A 70 C° max. 6.8 A 100 C° max. 5.4 A depends on cable
Air- and creepage distance			contact - contact 0.4 mm
Operating voltage	IEC 60664	The permissible operating voltages depend on the customer application and on the applicable or specified safety requirements. Insulation coordination according to IEC 60664-1 has to be regarded for the complete electrical device. Therefore, the maximum creepage and clearance distances of the mated connectors are specified for consideration as a part of the whole current path. In practice, reductions in creepage or clearance distances may occur due to the conductive pattern of the printed board or the wiring used, and have to be taken into account separately. As a result the creepage and clearance distances for the application may be reduced compared to those of the connector.	
Dielectric strength	IEC 60512 test 4a	contact – contact 500 V _{rms}	
Contact resistance	IEC 60512 test 2a	< 25 mΩ	
Insulation resistance	IEC 60512 test 3a	> 10 ⁴ MΩ	
Vibration, sine	IEC 60512 test 6d	10 – 2000 Hz 20 g	
Contact disturbance (while vibration test)	IEC 60512 test 2e	< 1 μs	
Shock halfsine	IEC 60512 test 6c	50 g 11 ms	
Contact disturbance (while shock test)	IEC 60512 test 2e	< 1 μs	

MiniBridge - 1.27 mm Connector

ELECTRICAL AND MECHANICAL CHARACTERISTICS IDC

Description	Standard	Male Connector IDC Type P	Female Connector IDC Type A and P
Mechanical operation	IEC 60512 test 9a		500 mating cycles
Insertion and withdrawal force	IEC 60512 test 13b		1 N per contact
Gauge retention force	IEC 60512 test 16e		> 0.1 N
Polarization	IEC 60512-13-5		60 N
Interlocking noise			40 dB (A)
Housing Material			
Plastic material			LCP
CTI value	IEC 112		175
UL flame rating			UL 94 V-0
UL file			E83005
Contact Material			
Base material			Cu alloy
Mating area			gold plating
Termination area			Sn
Environment compatibility			
Recycling		no flame-retardent additives, no toxic additives allow easy recycling	
Product-approval			
UL			E84703

MiniBridge - 1.27 mm Connector

ELECTRICAL AND MECHANICAL CHARACTERISTICS CABLE

CABLE DATA

Description	Standard Cable(PVC)	High Temperature Cable (TPE-ET)	Halogen-free Cable (TPE-0)
Cross Section	AWG-26/ 7/ 0.14 mm ²		
Conductor	Cu wire tin-plated		
Marking	available		
Insulation	PVC wall thickness min. 0.178 mm	TPE-ET wall thickness min. 0,2 mm	Polyolefin wall thickness min. 0,178 mm
Shore hardness	94 ±3 (Shore A)	96 ±3 (Shore A)	90 ±3 (Shore A)
Technical data			
Temperature range	-30/105 °C (unmoved) -20/105 °C (moved)	-60/125 °C (unmoved) -40/125 °C (moved)	-40/105 °C (unmoved) -20/105 °C (moved)
Voltage rating	max. 300 V		
Dielectric strength	2000 V _{rms}	1500 V _{rms}	1500 V _{rms}
Conductor resistance	≤ 135 Ω/km	≤ 138 Ω/km at 20 °C	max. 135 Ω/km at 20 °C
Insulation resistance	≥ 100 MΩ x km at 20 °C	≥ 20 MΩ x km at 20 °C	min. 20 MΩ x km at 20 °C
Capacitance at 1 kHz	GSG ≤ 60 pF/m	GSG 40 pF/m	GSG 40 pF/m
Inductance	GSG 0,9 μH/m at 10 KHz	GSG 0,79 μH/m at 10 KHz	GSG 0,95 μH/m at 1 KHz
Impedance	GSG 100 Ω	GSG 110 Ω	GSG 95 Ω
Crosstalk in %	Cable length 3 m: NE 5,4 / FE 6,8	–	–
Propagation delay	4,6 ns/m	6,2 ns/m	–
Flamability	UL VW-1; CSA FT-1	UL 1581 Sec. 1080, VW-1	UL 1581
Product-approval			
UL	AWM 2651	– *	AWM 21151
CSA	Yes	No	Yes

* UL Style 21739 on request

MiniBridge - 1.27 mm Connector

RIGHT ANGLE MALE SMT TYPE A

PRODUCT SPECIFICATION



- SMT termination
- Tape and Reel packaging for automatic assembly
- suitable for lead-free reflow soldering process
- white versions for lighting applications

DIMENSIONAL DRAWINGS

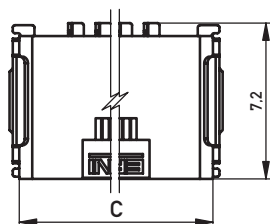
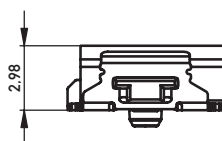
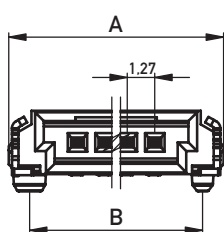

2	7.62	5.69	6.72
3	8.89	6.96	7.99
4	10.16	8.23	9.26
6	12.70	10.77	11.80
8	15.24	13.31	14.34
10	17.78	15.85	16.88
12	20.32	18.39	19.42
No. of contacts	A	B	C

Recommended Layout

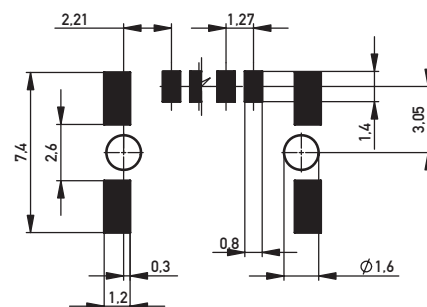



MiniBridge - 1.27 mm Connector

RIGHT ANGLE MALE SMT TYPE A —

ORDERING INFORMATION

No. of Pins	Color	Part Number
2	black	214011
2	white	384978
3	black	234450
4	black	214012
4	white	384979
6	black	214013
6	white	394574
8	black	214014
10	black	234464
12	black	234478



ERMEC, S.L. BARCELONA
C/ Francesc Teixidó, 22
08918 Badalona
(España)

Tel.: (+34) 902 450 160
Fax: (+34) 902 433 088
info@ermec.com
www.ermec.com

ERMEC, S.L. MADRID
c/Mejorada, 17,1ªPl. Of.D4
28850 Torrejón de Ardoz
(España)

PORTUGAL
portugal@ermec.com
BILBAO
bilbao@ermec.com

MiniBridge - 1.27 mm Connector

VERTICAL MALE SMT TYPE P

PRODUCT SPECIFICATION



- SMT termination
- Tape and Reel packaging for automatic assembly
- suitable for lead-free reflow soldering process
- with pick-and-place cover

DIMENSIONAL DRAWINGS

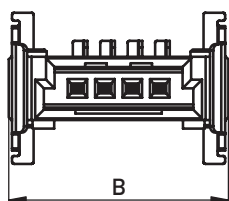
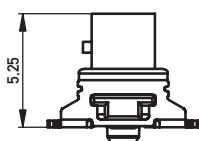
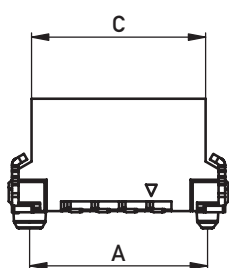

2	5.69	7.62	5.60
3	6.96	8.89	6.79
4	8.23	10.16	8.06
6	10.77	12.70	10.60
8	13.31	15.24	13.14
10	15.85	17.78	15.68
12	18.39	20.32	18.22
No. of contacts	A	B	C

Recommended Layout

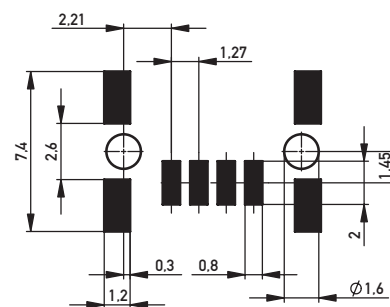



MiniBridge - 1.27 mm Connector

VERTICAL MALE SMT TYPE P —

ORDERING INFORMATION

No. of Pins	Color	Part Number
2	black	284695
2	white	464124
3	black	284696
4	black	284697
6	black	284698
6	white	284337
8	black	284699
10	black	294919
12	black	294920



ERMEC, S.L. BARCELONA
C/ Francesc Teixidó, 22
08918 Badalona
(España)

Tel.: (+34) 902 450 160
Fax: (+34) 902 433 088
info@ermec.com
www.ermec.com

ERMEC, S.L. MADRID
c/Mejorada, 17,1ªPl. Of.D4
28850 Torrejón de Ardoz
(España)

PORTUGAL
portugal@ermec.com
BILBAO
bilbao@ermec.com

MiniBridge - 1.27 mm Connector

RIGHT ANGLE FEMALE SMT TYPE P

PRODUCT SPECIFICATION

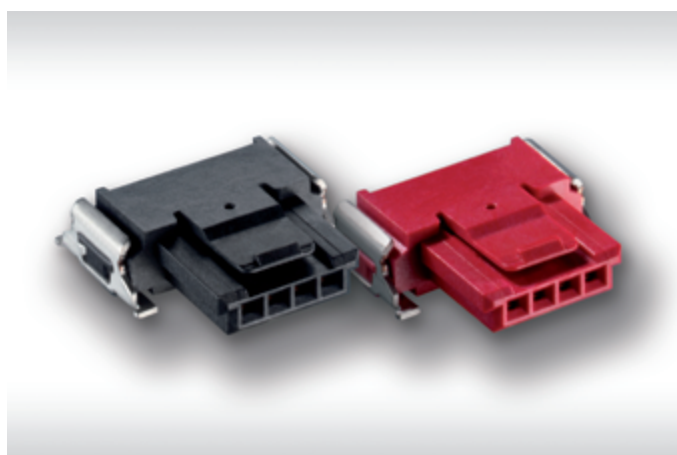

- SMT termination
- Tape and Reel packaging for automatic assembly
- suitable for lead-free reflow soldering process
- white versions for lighting applications
- two types of interlocking are available

DIMENSIONAL DRAWINGS

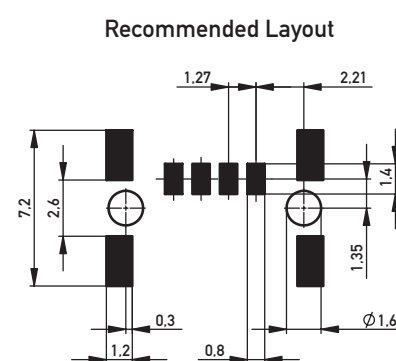
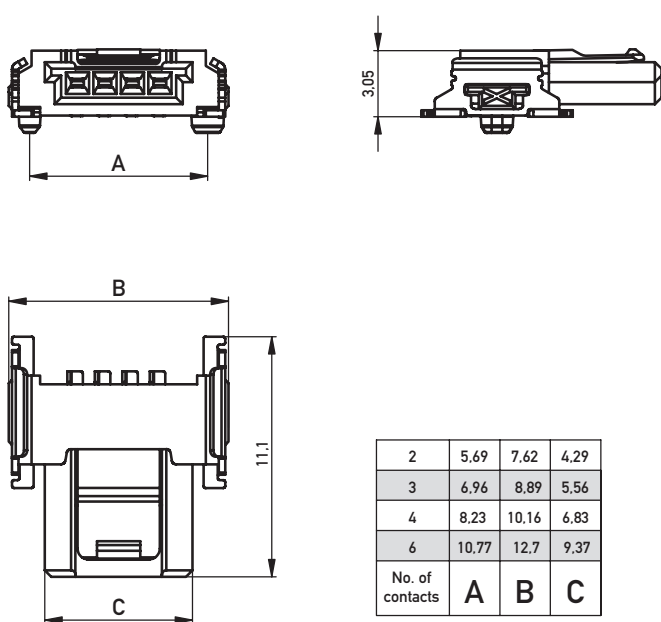



MiniBridge - 1.27 mm Connector

RIGHT ANGLE FEMALE SMT TYPE P

ORDERING INFORMATION

No. of Pins	Color	Interlocking	Part Number
2	black	friction lock	384845
2	red	positive lock	384840
2	white	friction lock	384974
3	black	friction lock	384846
3	red	positive lock	384841
4	black	friction lock	364485
4	red	positive lock	364484
4	white	friction lock	384975
6	black	friction lock	384804
6	red	positive lock	384803
6	white	friction lock	444750



ERMEC, S.L. BARCELONA
C/ Francesc Teixidó, 22
08918 Badalona
(España)

Tel.: (+34) 902 450 160
Fax: (+34) 902 433 088
info@ermec.com
www.ermec.com

ERMEC, S.L. MADRID
c/Mejorada, 17,1ªPlá.Of.D4
28850 Torrejón de Ardoz
(España)

PORTUGAL
portugal@ermec.com
BILBAO
bilbao@ermec.com

MiniBridge - 1.27 mm Connector

CABLE ASSEMBLIES

PRODUCT SPECIFICATION

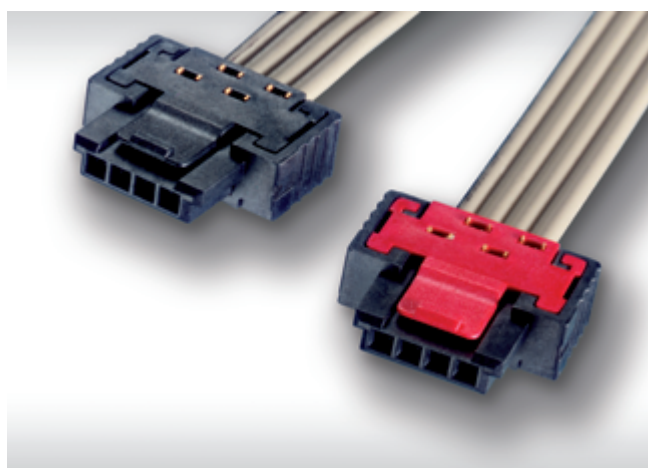

- IDC termination
- Ribbon cable AWG 26/7
- Discrete wire AWG 22/7, AWG 24/7 and AWG 26/7
- two types of interlocking are available

DIMENSIONAL DRAWINGS

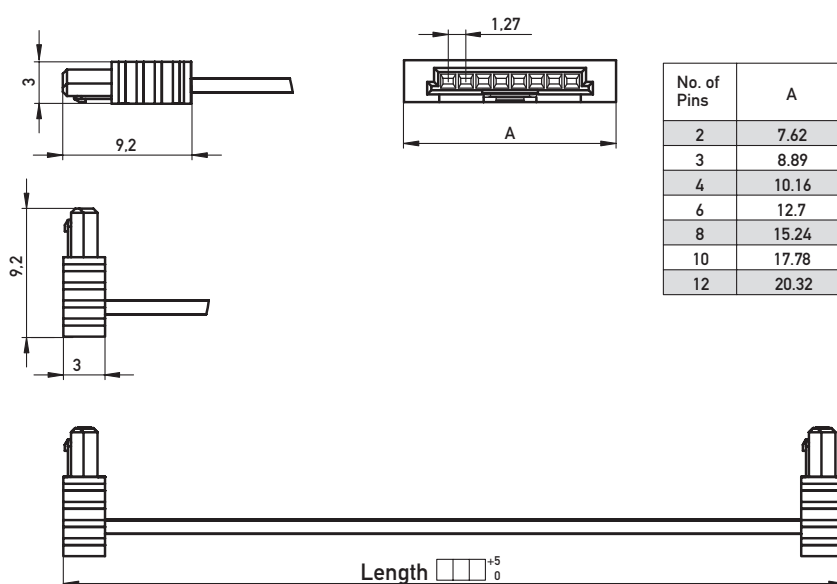

MiniBridge - 1.27 mm Connector

CABLE ASSEMBLIES

CODING AND INTERLOCKING

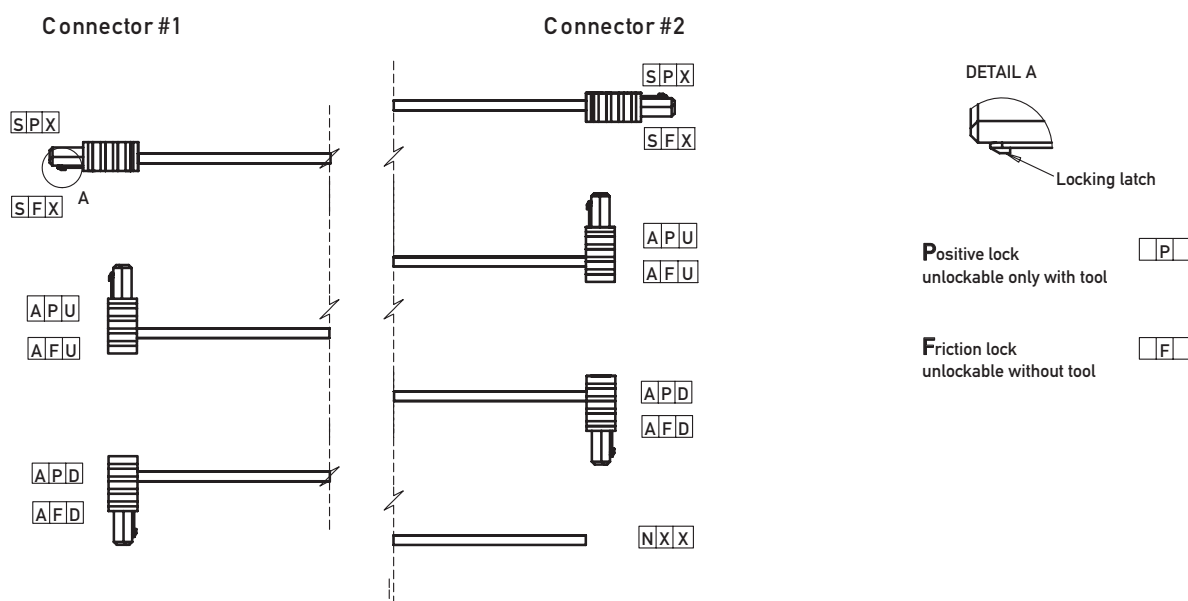

ORDER CODE STANDARD ASSEMBLIES

IDCCS_SRC_1.27 □□ □□□ □□□ □□□ □□

Cable Type

High Temperature AWG 26/7

PVC AWG 26/7

Halogen-Free AWG 26/7

Length (25 to 995 mm in 5 mm increments)

Connector #2

Connector #1

No. of Pins (2-digit: 02, 03, 04, 06, 08, 10, 12)

Discrete wire cable assemblies on request.



MiniBridge - 1.27 mm Connector

PART NUMBER INDEX —

Part Number	Page
214011	15
384978	15
234450	15
214012	15
384979	15
214013	15
394574	15
214014	15
234464	15
234478	15
284695	17
464124	17
284696	17
284697	17
284698	17

Part Number	Page
284337	17
284699	17
294919	17
294920	17
384845	19
384840	19
384974	19
384846	19
384841	19
364485	19
364484	19
384975	19
384804	19
384803	19
444750	19



ERMEC, S.L. BARCELONA
C/ Francesc Teixidó, 22
08918 Badalona
(España)

Tel.: (+34) 902 450 160
Fax: (+34) 902 433 088
info@ermec.com
www.ermec.com

ERMEC, S.L. MADRID
c/Mejorada, 17,1ªPl.a.Of.D4
28850 Torrejón de Ardoz
(España)

PORTUGAL
portugal@ermec.com
BILBAO
bilbao@ermec.com



ERMEC, S.L. BARCELONA
C/ Francesc Teixidó, 22
08918 Badalona
(España)

Tel.: (+34) 902 450 160
Fax: (+34) 902 433 088
info@ermec.com
www.ermec.com

ERMEC, S.L. MADRID
c/Mejorada, 17,1ªPl.a.Of.D4
28850 Torrejón de Ardoz
(España)

PORTUGAL
portugal@ermec.com
BILBAO
bilbao@ermec.com

ERNI Electronics GmbH & Co. KG

Europe South America Africa Japan

Seestrasse 9
73099 Adelberg
Germany
Tel +49 7166 50-0
Fax +49 7166 50-282
info@erni.com
www.erni.com

ERNI Electronics, Inc.

North America Canada Mexico

2201 Westwood Ave
Richmond, VA 23230/USA
Tel +1 804 228-4100
Fax +1 804 228-4099
info@erni.us

ERNI Asia Holding Pte Ltd.

Asia

Blk 4008 Ang Mo Kio Avenue 10
#04-01/02 Techplace I
Singapore 569625
Tel +65 6 555 5885
Fax +65 6 555 5995
info@erni-asia.com

© ERNI Electronics GmbH & Co. KG 2014 • Printed in Germany • A policy of continuous improvement is followed and the right to alter any published data without notice is reserved.

ERNI®, ERNI WoR&D®, Act. Connect. Perfect®, MicroCon®, MicroStac®, MicroSpeed®, MiniBridge®, MaxiBridge®, ERmet®, ERmet ZD®, ERmet ZDplus®, ERmet ZD HD®, ERbic®, ERNIPRESS®, INTERact®, BLUEcontact® and WHITEspeed® are trademarks (registered or applied for in various countries) of ERNI Electronics GmbH & Co. KG.



ERMEC, S.L. BARCELONA
C/ Francesc Teixidó, 22
08918 Badalona
(España)

Tel.: (+34) 902 450 160
Fax: (+34) 902 433 088
info@ermec.com
www.ermec.com

ERMEC, S.L. MADRID
c/Mejorada, 17,1ªPla.Of.D4
28850 Torrejón de Ardoz
(España)

PORTUGAL
portugal@ermec.com
BILBAO
bilbao@ermec.com